

Wood Pellets Burner Version 6



Content list:

Site 2:	INSTALLATION GUIDE FOR OPOP BOILER
Site 3:	INSTALLATION GUIDE FOR OPOP / NBE BOILER
Site 4:	BOILER INSTALLATION GUIDE
Site 5:	SETTING BY WEIGHT
Site 6-11:	USER GUIDE
Site 12:	EXTENDED SET-UP GUIDE
Site 13:	CLEANING GUIDE
Site 14:	MAINTAIN GUIDE
Site 15:	TROUBLESHOOTING
Site 16-17:	ELECTRICAL WIRING DIAGRAMS
Site 18:	ACCESSORIES
Site 19:	WARANTY
Site 20:	MOUNTING THE PELLET HOPPER
Site 21:	EXCEPTION FOR PRESSURE EXPANSION
Side 22:	EC DECLARATION OF CONFORMITY

EN 303-5 approved by DTI (Danish Technological Institute)
Approved for pressure expansion
Energy class AA



Manual

NBE pellet system

INSTALLATION GUIDE FOR OPOP BOILER

	OPOP	H 418	H 430	H 440	H 460	Comfort
A Height		865	1005	1025	1105	1145
B Depth		670	670	830	910	730
C Width without burner		386	490	550	850	700
D Height smoke pipes		635	755	890	860	770
E Height Returns		99	99	215	200	230
F Height Output		781	921	1150	1045	930
G Boiler feet deep		470	470	710	640	620
H Boiler feet Wide		316	420	510	750	670
Hole to burner H x B		120x120	195x175	150x150	235x240	120x120
Smoke tube outer D		130	130	158	158	130
Pipe connections		1-1/4	1-1/4	1-1/4	1-1/4	1-1/4

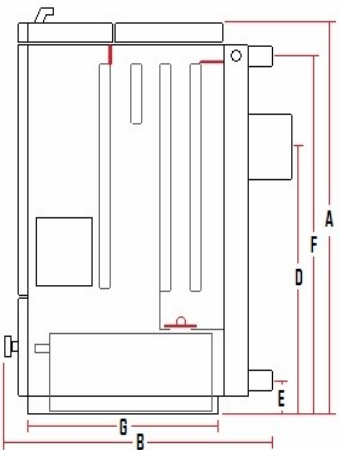

General guidelines:

The boiler should be installed by an authorized fitter and must be installed in accordance with work supervision publication 42 (Danish) covering equipment working with water. The outlet duct should be no longer than 1m, and should be fitted with a cleaning door. The chimney draught should be at least 5 PA and should be stable, a draught stabilizer should always be installed. If combustion gases condense in the chimney (wet ash) install a draught stabilizer in the chimney, or open the flue (the flap inside at the back of the boiler) as wide as possible to increase the temperature of the smoke. The boiler must be spanned with a bypass to ensure the back flow is always kept above 45 degrees.

Installing the burner into the boiler:

1. Install the burner on the side of the boiler
(there should be no shield on the burner, when using the comfort boiler).
2. Fit the controls either on the cabinet or on the wall.
3. Install the overheating safety cut off into the pocket on the side of the boiler, and connect the controls so that the overheating safety cut off will cut the power if the boiler overheats.
4. Install the heat sensor on the output flow, either in the pocket or by the sensor on the output flow. (The sensor must be insulated to the output flow.)
5. Fit the pipe on the drop shaft.
6. Fit the hopper and auger so that the pipe slopes.
(PELLETS MUST NOT GET STUCK IN THE PIPE.)

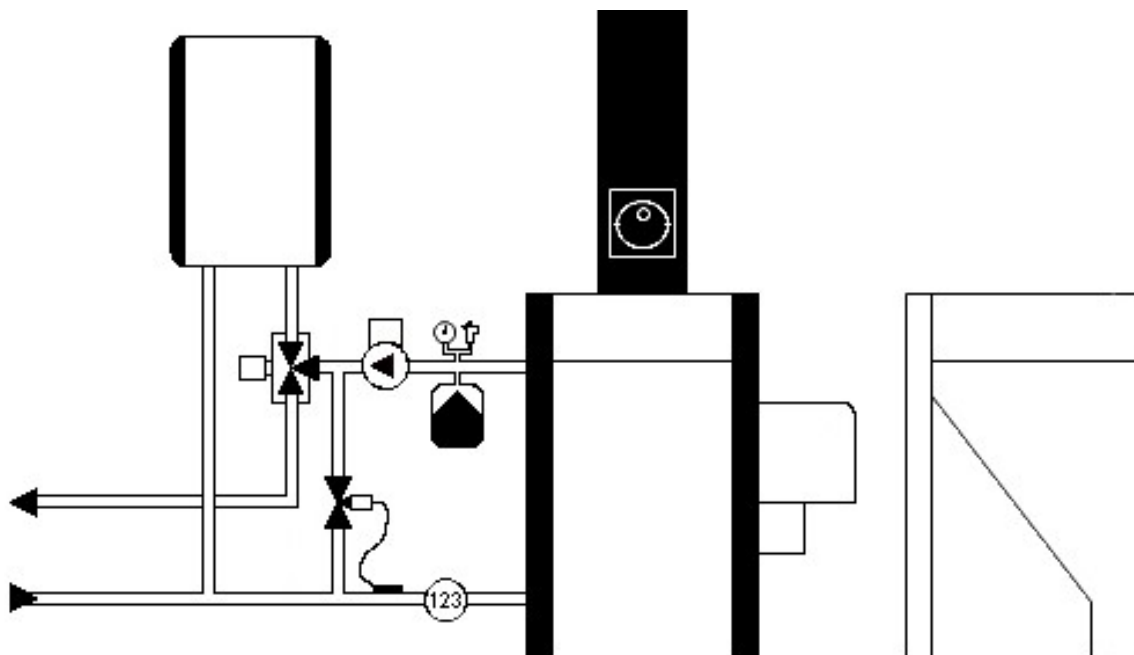

Diag. Example of installation

Manual

NBE pellet system

INSTALLATION GUIDE FOR OPOP / NBE BOILER

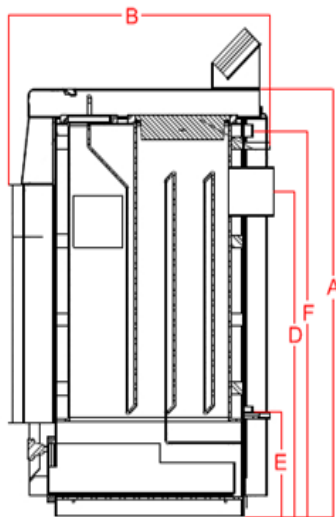

NBE / OPOP	30 S	60 M	80 L
A Height	1142	1272	1272
B Depth	750	896	1003
C Width without burner	513	643	743
D Height smoke pipes	885	997	997
E Height Returns	276	276	283
F Height Output	1030	1161	1154
Smoke tube outer D	130	150	180
Pipe connections	3/4"	1"	1 1/4"
Pipe connections	1/2"	1/2"	1/2"
Weight	250	300	350
Water content	75	105	125
Hole to burner H x B	152x132	180x180	248x248

General guidelines:

The boiler should be installed by an authorized fitter and must be installed in accordance with work supervision publication 42 (Danish) covering equipment working with water. The outlet duct should be no longer than 1m, and should be fitted with a cleaning door. The chimney draught should be at least 5 PA and should be stable, a draught stabilizer should always be installed. If combustion gases condense in the chimney (wet ash) install a draught stabilizer in the chimney, or open the flue (the flap inside at the back of the boiler) as wide as possible to increase the temperature of the smoke. The boiler must be spanned with a bypass to ensure the back flow is always kept above 45 degrees.

Installing the burner into the boiler:

1. Install the burner on the side of the boiler (there should be no shield on the burner, when using the comfort boiler).
2. Fit the controls either on the cabinet or on the wall.
3. Install the overheating safety cut off into the pocket on the side of the boiler, and connect the controls so that the overheating safety cut off will cut the power if the boiler overheats.
4. Install the heat sensor on the output flow, either in the pocket or by the sensor on the output flow. (The sensor must be insulated to the output flow.)
5. Fit the pipe on the drop shaft.
6. Fit the hopper and auger so that the pipe slopes.
(PELLETS MUST NOT GET STUCK IN THE PIPE.)

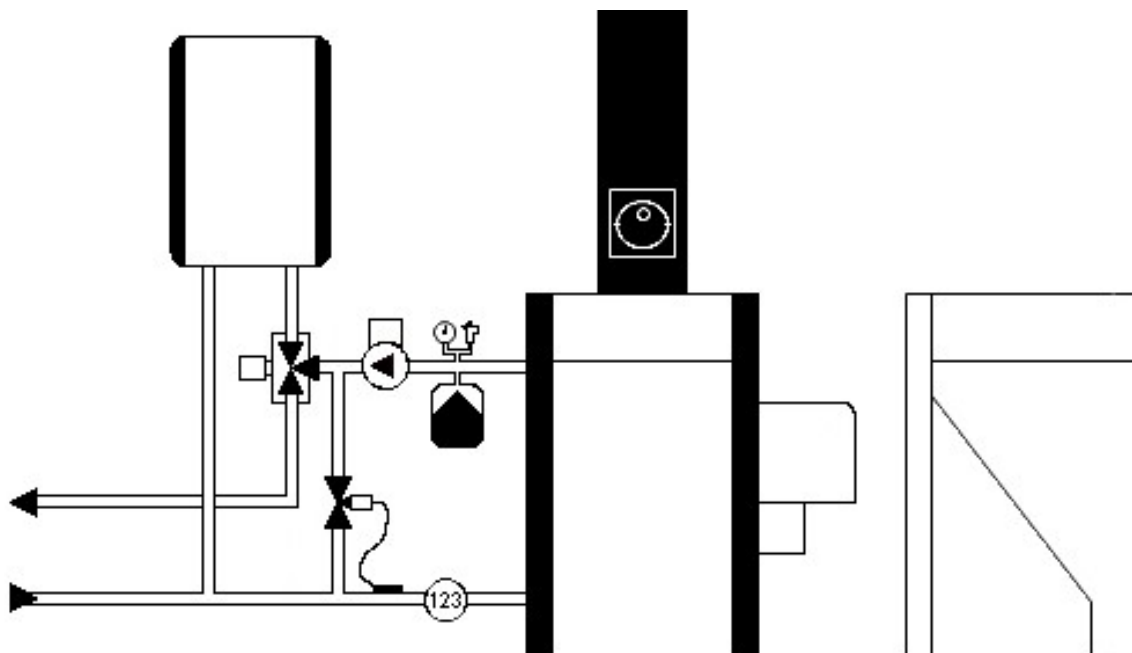

Diag. Example of installation

Manual

NBE pellet system

BOILER INSTALLATION GUIDE

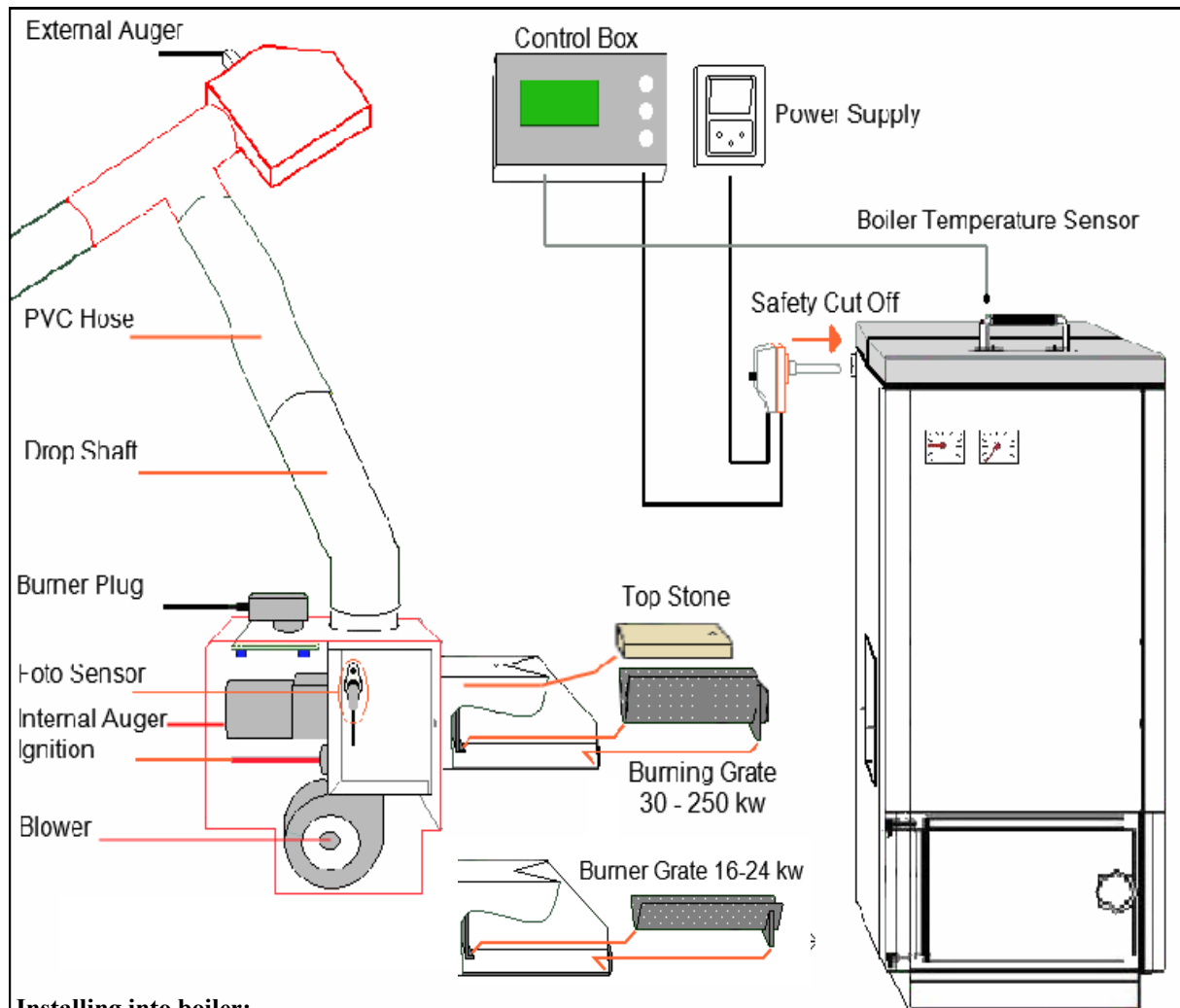

Installing into boiler:

1. Check that the burner is undamaged.
2. Fit the burner and tighten it firmly using the two wing nuts supplied.
3. Ensure that the burner is in a horizontal position and all connections are tight.
4. Fit the cover and the plug.
5. Wire up the overheating safety fuse following the electrical wiring diagram.

Outer auger:

6. Install the auger through the opening over the burner.
7. Ensure that the pipe slopes enough to allow the pellets to fall into the burner.

When using for the first time:

8. Make sure there are enough pellets by the entrance to the outer auger.
9. Force-start the auger by holding down the UP button by the power input point.
10. If the pellets fall into the combustion chamber, turn off again by pressing DOWN. Then restart the burner using electrical ignition.

Turning off the alarm:

11. If the alarm goes off or the burner will not start, Press down button to reset alarm

Manual

NBE pellet system
SETTING BY WEIGHT

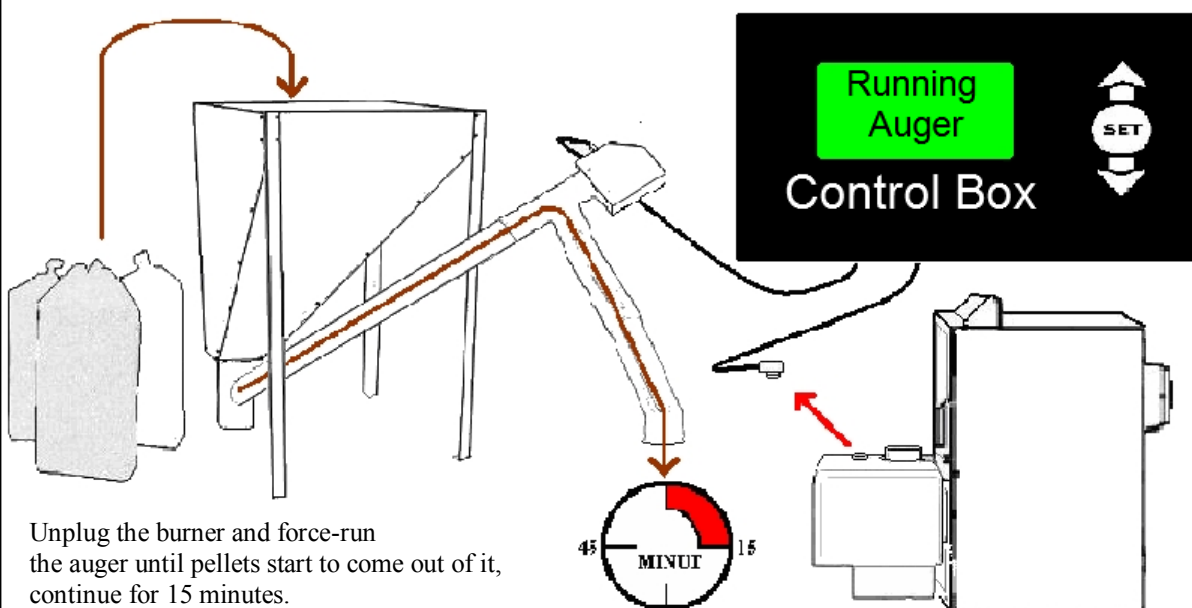

Unplug the burner and force-run the auger until pellets start to come out of it, continue for 15 minutes.

Running Auger
Control Box

45 MINUT 15

Diagram illustrating the first step: the burner is unplugged, and the auger is force-run for 15 minutes. The control box shows the 'Running Auger' menu item highlighted in green, and a timer is set to 15 minutes.

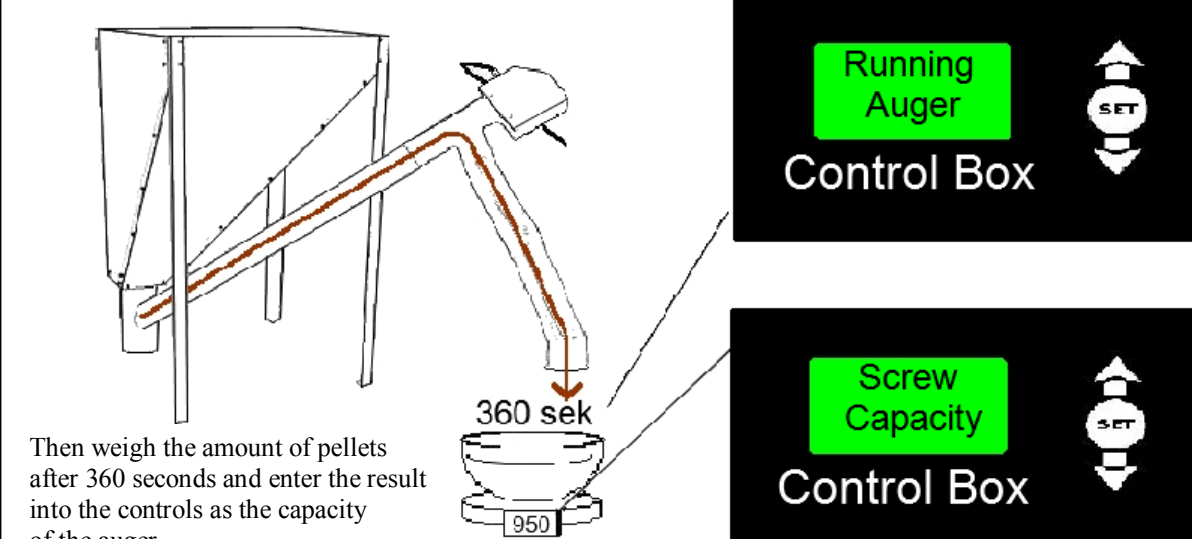

Then weigh the amount of pellets after 360 seconds and enter the result into the controls as the capacity of the auger.

Running Auger
Control Box

Screw Capacity
Control Box

360 sek
950
GRAM

Diagram illustrating the second step: the auger is run for 360 seconds, and the amount of pellets is weighed. The control box shows the 'Screw Capacity' menu item highlighted in green, and the timer is set to 360 seconds. The scale shows 950 GRAM.

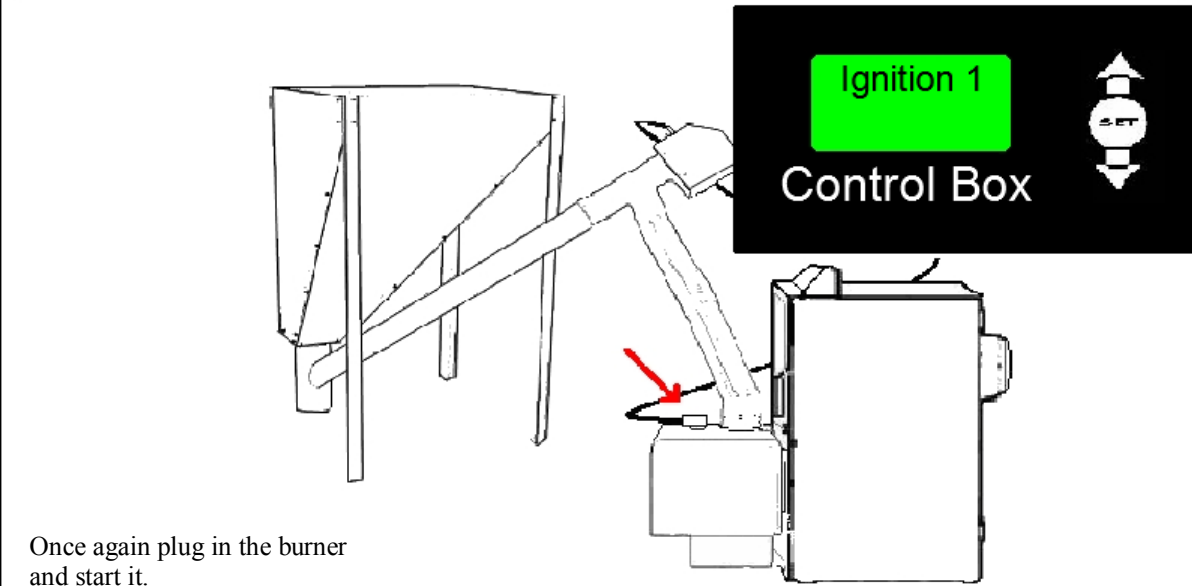

Once again plug in the burner and start it.

Ignition 1
Control Box

Diagram illustrating the final step: the burner is plugged in, and the system is started. The control box shows the 'Ignition 1' menu item highlighted in green.

Manual

NBE pellet system
USER GUIDE

There can be 3 run mode to see in the display
You change by pressing up / down

RUN MODE 1:

Boiler temp./ Smoke temp. / Hot water temp.
Return temp./ Tank content / Light sensor / Kwh / Clock mode.
Circulation Pump / 3 way valve. / Ignition.
When making ignition, you can see time counting down.

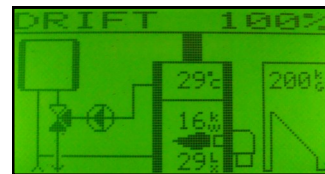

RUN MODE 2:

Boiler temp. / Return temp. / Smoke temp. / O2 %.
Flow system. / Kwh / light sensor. / Burner temp.
Circulation Pump / Ignition
When making ignition, you can see time counting down.

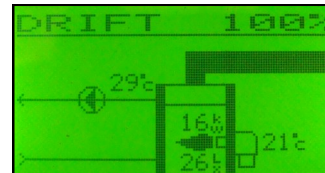

RUN MODE 3:

Watt pr m2. / Outside temp. / Tank content / Total hour /
Total use of pellets. / Time

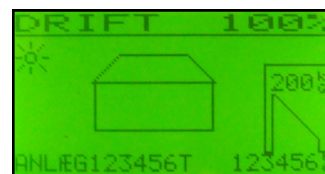

Press **SET** and the display will show SETUP for standard settings.

The **UP** button is used to increase the setting and for force-running the auger (hold for longer than 5 seconds).

To force run the auger for an long time , hold UP button while switching power to control box

The **DOWN** button is used to decrease the setting and switch the controls on/off (hold for 10 seconds).

Resets alarms.

Temperature

Magazine

Auto combustion

Man. combustion

Timer

Cleaning / power

O2 Control

BOILER TEMP.

Setting the required boiler temperature.

The burner sets the performance higher or lower depending on the figure entered (set point).

DIFFERENCE TEMP.

The setting defining how far the boiler temperature, can go over set point before pause or stop.

HOT WATER TEMP.

Setting the required hot water temperature.

Only to be adjusted if hot water temp. sensor and 3 way valve is fitted. and activated in accessories in the Tech Setup. (3 way valve on L5 or L6)

DIF. HOTWATER

The setting defining how far the temperature can drop, before starting making hot water again.

PUMP STOP TEMP.

The setting defining what temperature the pump stops, pump will always run, when the pellets burner is burning.

Must be activated in accessories in the Tech Setup (pump on L5 or L6)

SUMMER STOP .

The setting defining what outside temperature the burner stops, .

An outside temperature sensor must be fitted in T5

SUN STOP .

The setting defining how power full the sun must be before the burner stops, .

An W/m2 sensor must be fitted in T6

CALIBRETING SUN STOP .

The sensor calibrating it self to 1000w/m2

If it is out of range it can be done manual.

Manual

NBE pellet system
USER GUIDE

Temperature

Magazine

Auto combustion

Man. combustion

Timer

Cleaning / power

O2 Control

ACTUAL CONTENT

Adjusting the content of the magazine.

RESET CONSUMPT.

Putting the pellets kg counter to zero.

Temperature

Magazine

Auto combustion

Man. combustion

Timer

Cleaning / power

O2 Control

SCREW CAPACITY

After setting the auger performance in 360 seconds the control will automatically calculate the amount of pellets in low power and high power, pellets in pause, and pellets for ignition

Under normal conditions these numbers will be correct.

To increase combustion, set the value **DOWN**.

To reduce combustion, set the value **UP**.

CHIMNEY DRAUGHT

With a strong chimney draught the ventilator performance will be higher, At low steam and during pause.

If the amount of chimney draught is increased,

the automatic calculation sets more pellets in low steam and during pause.

The smaller the chimney draught and the greater the back pressure of the boiler, the lower the value must be.

The greater the chimney draught and the lower the back pressure of the boiler, the higher the value must be

YES/NO

Switching automatic calculations on/off.

If automatic calculation is on, only the auger performance can be set.

Temperature

Magazine

Auto combustion

Man. combustion

Timer

Cleaning / power

O2 Control

PELLETS LOW

Setting the amount of pellets for low performance.

Should be set so there is a flame when running 10% power.

NOTE: can only be adjusted if auto combustion is on NO

PELLETS HIGH

Setting the amount of pellets for full performance.

Should be set so that combustion is powerful when running at 100% power.

NOTE: can only be adjusted if auto combustion is on NO

PAUSE PELLETS

Setting the amount of pellets for during lag.

If in doubts about the settings, use the automatic calculation program.

NOTE: can only be adjusted if auto combustion is on NO

STARTS / MINUTE

Setting how many time auger is running / minute.

Manual

NBE pellet system
USER GUIDE

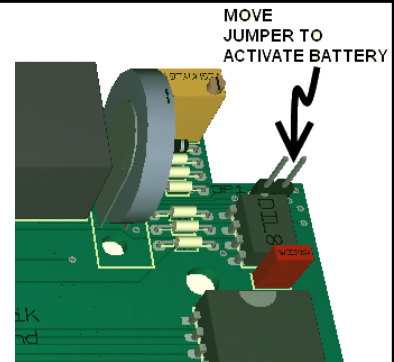

Temperature
Magazine
Auto combustion
Man. combustion
Timer
Cleaning / power
O2 Control

CLOCK

Setting the clock.

PERIOD HEATING

Setting the running time, when clock is starting the burner.

1.START HEATING

Starts the burner at this time , running time will be “period heating”

2.START HEATING

Starts the burner at this time , running time will be “period heating”

3.START HEATING

Starts the burner at this time , running time will be “period heating”

4.START HEATING

Starts the burner at this time , running time will be “period heating”

PERIOD H. WATTER

Setting the running time, when clock is starting making hot water.

1.START H. WATER

Starts the burner at this time , running time will be “period heating”

2.START H. WATER

Starts the burner at this time , running time will be “period heating”

3.START H. WATER

Starts the burner at this time , running time will be “period heating”

HH:MM

HH:MM

HH:MM

HH:MM

HH:MM

HH:MM

HH:MM

HH:MM

HH:MM

Temperature
Magazine
Auto combustion
Man. combustion
Timer
Cleaning / power
O2 Control

CLEANING INTERVAL

Sets how often the burner should be cleaned.

If you often heat on low load, the interval can be reduced to 5 minutes, with 5 seconds of cleaning.

CLEANING TIME

Set the cleaning time.

The shorter the intervals the shorter the time should be.

BLOWER CLEANING

Setting the power of blower when the burner cleaning.

MINIMUM POWER

Setting minimum performance.

If the pellet burner always works on low load and is having some difficulties, the minimum performance can be increased so the burner occasionally turns off.

MAXIMUM POWER

Setting maximum performance.

If the pellet burner rapidly reaches a high temperature, the maximum performance should be reduced.

COMPRESSOR CLEANING

Adjusting after how many kg of pellets, the burner make an compressor cleaning
Compressor cleaning must be fitted and activated in accessories in the Tech setup (magnet air valve on L5 or L6)

COMPRESSOR WAIT

Adjusting how long time before activating compressor cleaning, the burner stop feeding pellets to the combustion.

COMPRESSOR TIME

Adjusting how long time the air valve is open when cleaning.

COMPRESSOR BLOWER

Adjusting the blower speed when cleaning with compressor.

Manual

NBE pellet system
USER GUIDE

NOTE:

When using the O2 controller, 6 Minutes of pellets must be weighted and inserted in screw capacity.

Temperature

Magazine

Auto combustion

Man. combustion

Timer

Cleaning / power

O2 Control

O2% MIN POWER

The amount of excess oxygen in the smoke at low performance.

Sets the amount of fuel so that the excess oxygen is at the required amount.

If the pellet burner smokes at low performance, set a higher percentage of oxygen.

If the photo sensor has problems recognizing the ignition, this could be caused by the ignition being too weak; set a higher value to increase the feed.

The flame should be yellowish.

O2% MAX POWER

The amount of excess oxygen in the smoke at full performance.

Sets the amount pellets so that the excess oxygen is at the required amount.

If the pellet burner smokes at full performance, set a higher percentage of oxygen.

If the flame is angry and sputtering, set a lower percentage of oxygen.

OFF / DISPLAY / ON

Turns oxygen regulation on/off.

Oxygen regulation set to ON –

The burner sets the amount of pellets to suit the required percentage of oxygen.

Oxygen regulation set to DISPLAY –

You can read the percentage, but the burner does not set the amount of pellets.

The tighter the boiler, the more you get from oxygen regulation.

It is recommended to fit the chimney with a draught stabilizer, this will reduce the draught and cut the amount of air flowing back into the boiler.

TECH SETUP

(Press the SET button for 8 seconds.)

Ignition

Pause

O2

Fine tune

PID regulation

Temp. alarm

Accessories

PELLETS

Setting the amount of pellets for ignition.

NOTE: can only be adjusted if auto combustion is on NO.

PERIOD

Setting maximum ignition duration.

POWER

Setting performance of electrical ignition.

FIRE LIMIT

Setting amount of light required to interrupt ignition.

BLOWER IGNITION

Setting the blower speed at ignition.

TOTAL STARTS

The total number of time the ignition has been used.

TOTAL HOUR

The total hours the ignition has been used.

Ignition

Pause

O2

Fine tune

PID regulation

Temp. alarm

Accessories

MAX MINUTES

Maximum pause time, 245 = pause always, 0= off
burner will then ignite electrically automatic after stop.

BLOWER PAUSE

Blower speed during pause.

PAUSE DIFFERENCE TEMP.

The setting defining how far the boiler temperature is dropping below the desired value before the burner restarts.

EXTINGUISH TIME

Stopping / cleaning blower time

Very important that time is long enough to burn the last remaining pellets in the burner head, to prevent over heating,

Manual

NBE pellet system
USER GUIDE

<p>Ignition Pause O2 Fine tune PID regulation Temp. alarm Accessories</p>	<p>O2 SENSOR TUNE Calibration of oxygen sensor to ensure it gives accurate readings. Hold the exhaust gas oxygen sensor in the air and calibrate it to give it a reference value to the air (21% oxygen). If the sensor by mistake don't calibrate between 10 and 40 it cant be turned on. WARNING! The oxygen sensor must be warm when calibrating. BLOCKING TIME Auger stops feeding when oxygen has been 2 % below set point in X time. Used for wood firing. REGULATION TIME Adjustment of updating time on lambda sensor. GAIN P Sets how much oxygen regulation should regulate according to how far the level is from the set point. GAIN I Sets how much oxygen regulation should regulate according to how long time the level has been from the set point. BLOWER REG LOW Adjusting how much oxygen regulation can regulate the blower in low power. BLOWER REG MID Adjusting how much oxygen regulation can regulate the blower in mid power. BLOWER REG HIGH Adjusting how much oxygen regulation can regulate the blower in high power.</p>
<p>Ignition Pause O2 Fine tune PID regulation Temp. alarm Accessories</p>	<p>BLOWER LOW Corrects the blower, so it fit the calculation program at low feed, used in special conditions causing a difference in calculations. BLOWER MID Corrects the blower, so it fit the calculation program at mid feed, used in special conditions causing a difference in calculations. BLOWER HIGH Corrects the blower, so it fit the calculation program at high feed, used in special conditions causing a difference in calculations. IGNITION Adjust the calculation program results for quantity of pellets in ignition, used in special conditions causing a difference in calculations. PAUSE MODE Adjust the calculation program results for quantity of pellets pause, used in special conditions causing a difference in calculations.</p>
<p>Ignition Pause O2 Fine tune PID regulation Temp. alarm Accessories</p>	<p>P - GAIN Shifts performance in relation to deviation from required temperature. NOTE: If you find the burner to slow, then 2-3 double the P-GAIN. I - GAIN Shifts performance in relation to the time the pellet burner deviated from the required temperature. D - GAIN Shifts performance in relation to the temperature trend of the boiler. BURNER TEMP. MAX Indicates the maximum temperature the burner can reach; protects against back combustion. BOILER TEMP. DIFF. Indicates the maximum deviation from the set point temperature of the boiler before the burner triggers the alarm to signal a temperature drop caused by an error, etc. If the burner takes more than 2 hour to get over set point of boiler minus boiler temp diff. The burner will go in LOW BOILER TEMP ALARM</p>

Manual

NBE pellet system
USER GUIDE

Ignition
Pause
O2
Fine tune
PID regulation
Temp. alarm
Accessories

BURNER TEMP. MAX

Indicates the maximum temperature the burner can reach; protects against back combustion.

BOILER TEMP. MIN.

Indicates the minimum temperature of the boiler, before the control box monitors, that boiler temperature raise again, if the temperature fails to raise in 10minutes triggers the alarm COLD BOILER.

Ignition
Pause
O2
Fine tune
PID regulation
Temp. alarm
Accessories

FLOW (L / PULS)

Adjustment of the flow counter on the boiler.

Used for calculation of KwH in the display and L/hour

Requires flow counter and return boiler temperature sensor.

CIRCULATION PUMP

(NO - L5 - L6)

Setup the output on control board for circulation pump

HOT WATER

(NO - L5 - L6)

Setup the output on control board for circulation pump

Requires 3 way valve and hot water temperature sensor.

COMPRESSOR

(NO - L5 - L6)

Setup the output on control board for compressor cleaning

Requires compressor cleaning kit

Manual

NBE pellet system EXTENDED SET-UP GUIDE

SETTING THE CONTROLS

The controls work in 100 step modulation and change these step automatically.



If you use the automatic calculation program after measuring the performance of the auger, no further setting should be necessary.

Setting pellets at low and full load...

During normal everyday use it is recommended to occasionally check the combustion and assess the flames. Whenever the heating pellets are changed (size or length of pellets, etc. ...), the dosing rate of the auger will also change, which will affect combustion. (However, if the burner is equipped with oxygen regulation, the burner will regulate this automatically.)

If there is a big flame on low load (10-30% performance)

(Dark, or black tips) or the ash is black.
In this case fewer pellets are required at low load.
(Reduce the chimney draught or reduce the pellets low)

If there is a big flame on full load (70-100% performance)

(Dark, or black tips) or the ash is black.
In this case fewer pellets are required at full load.
(Increase the performance of the auger or reduce the pellets high.)

If there is a weak flame on low load (10-30% performance)

(Small flame and sputtering stars) or the ash is light grey.
In this case more pellets are required.
(Increase the chimney draught or set the pellets low higher).

If there is a weak flame on full load (70-100%)

(Small flame and sputtering stars) or the ash is light grey, with dark pellets.
In this case more pellets are required.
(Reduce the performance of the auger or set the pellets high higher.)



**The pellet burner must not smoke, but must be sealed tight.
(Take care that smoke does not mingle with condensed steam.)**

**Correct combustion normally results in dark grey ash,
although this can vary slightly depending on the type of pellets used.
White and light ash in the boiler means excess air.**

Having the boiler set up correctly has a great effect on the economy of burning wooden pellets

Small 10 % flame.
Photo sensor will have problems to see light.

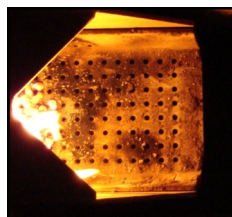

Correct 10% flame



Small 100 % flame.
A lot of unnecessary air.
Cool down the boiler.
Can cause black pellets in the ash.

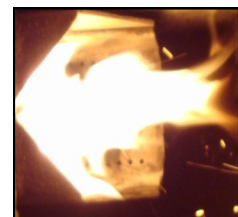

Correct 100 % flame.
Big and powerful.
With red colours

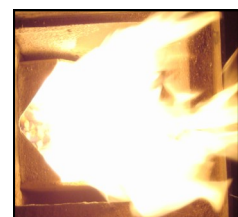

Fuel type

The boiler is set up for wooden pellets Ø 5-8mm, which do not burn to cinders!! (Hard ashes)

Manual

NBE pellet system
CLEANING GUIDE

When cleaning, turn off the burner...

Turn off the controls (hold the on/off button down for 10 seconds) and let the burner cool down for about 3 minutes, when it is completely switched off the burner is ready to be cleaned. Unplug the burner, remove the cover and the drop shaft, and unscrew the burner from the boiler before continuing.



The burner should be cleaned regularly and whenever necessary. This will ensure that the burner runs as economically as possible. The more suitable the boiler you have and the better the pellets you use, the longer the intervals between each cleaning session.

Area for
Cleaning

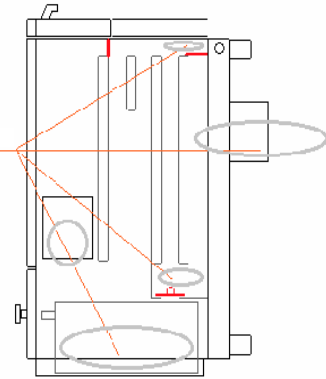

The boiler...

Clean the ash out of the boiler and brush off all the surfaces to remove any deposits. Be very careful of the ash in the backflow valve and the chimney pipe. The chimney-sweeper **DO NOT CLEAN** the chimney pipe, you must do this yourself... An old vacuum cleaner or ash bucket are especially suitable, as the ash does not normally contain carbon particles or tar.

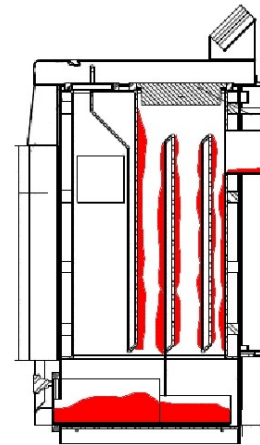

Combustion heads...

Remove the ash and any cinders from the grate. Remove any remnants of pellets from underneath the grate. Wipe the flame indicator. Ensure there is nothing in the ventilator.



**VERY IMPORTANT!!!
THE COMBUSTION HEAD WILL
BE DAMAGED IF THE GRATE IS
NOT POSITIONED CORRECTLY!!!**

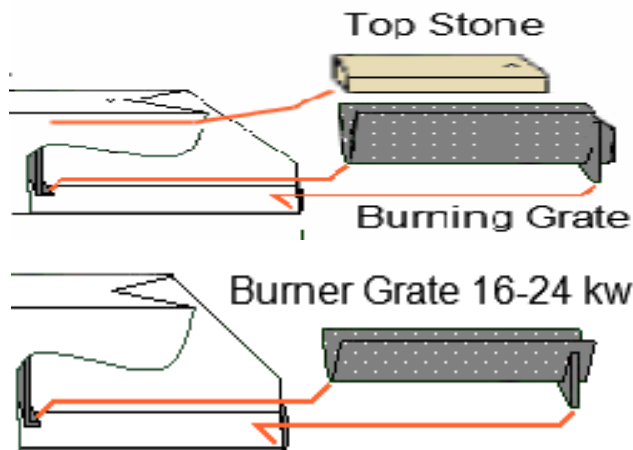

Pellet hopper...

As the pellets you put in the hopper contain detritus, the hopper should be completely emptied from time to time. The more detritus there is in the hopper, the less the auger feeds, which can interfere with the settings cause the burner to cut out. The frequency with which you empty the pellet hopper depends entirely on the angle inside of the hopper and the quality of the pellets you use.

Restarting after cleaning...

Reassemble the pellet burner and ignite it (hold the on/off button down for 10 seconds), at which point the burner will start automatically. **DO NOT FORGET** to replace the cover, to ensure that the temperature of the combustion chamber is measured correctly.

Manual

NBE pellet system MAINTAIN GUIDE

To make sure that you get an good experience with an pellets burner it is important that you maintain it correct.

If required	7 day	14 day	30 day	1/2 year	Every year	
x	x	x				Cleaning the burner head, if there is hard ashes.
		x	x			Cleaning below the burner grate for dust and ashes.
x			x	x		Cleaning the photo sensor for dust and soot
				x	x	Cleaning the blower for dust
x		x	x			It is important that errors and defective parts corrected / replaced immediately Cleaning the burner and the boiler.
x			x	x		Cleaning the chimney pipe and the back of the boiler.
					x	Control sealing and replace worn-out sealing.
x						Adjust the burning.
x	x	x				Refill the magazine
				x	x	Run the magazine empty
					x	Chimney sweeper

The schedule is indicative, there must always be cleaned as needed.

Cleaning is very individual, since the choice of pellets, system and adjustment of the pellet burner have a major impact on cleaning intervals.

It is important that errors and defective parts corrected / replaced immediately.

One should always have a photo sensor and an ignition in reserve.

A properly adjusted pellets burner, do not make mistakes or have downtimes.

If it do so, contact your dealer to find the error / adjusting the burner.

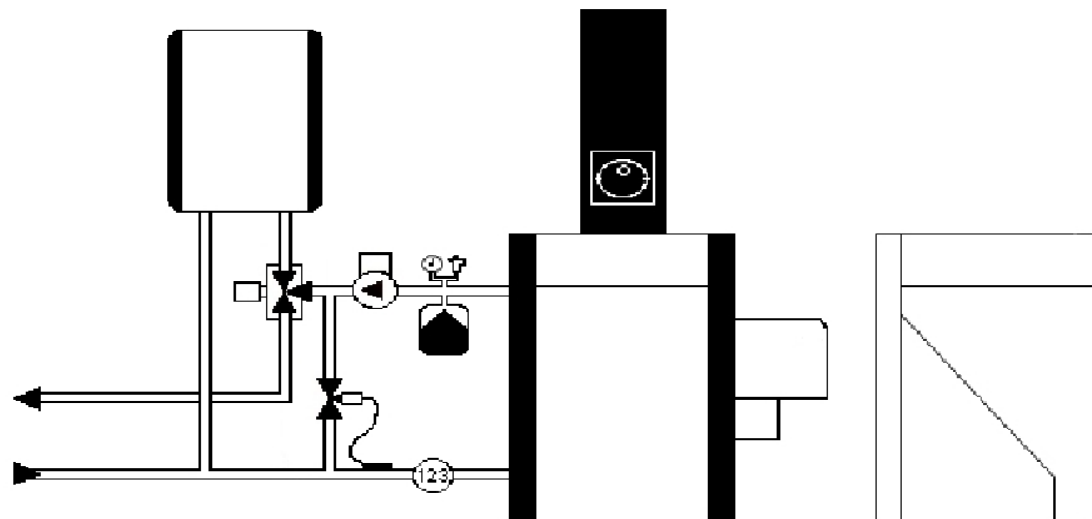

 FLOW COUNTER FOR READING kWh AND L/HOUR

 3 WAY VALVE FOR HOT WATER

 EKSPANSION TANK WITH SAFETY VALVE

 BOILER SHUNT

 DRAFT STABILISATOR

Manual

NBE pellet system
TROUBLESHOOTING

Problem	Cause	Solution
ALARM HOT DROP SHAFT OR BACK SMOKE	<ol style="list-style-type: none"> 1. Cinders/ash in the combustion head. 2. Ash in the boiler, smoke pipe and chimney. 3. Backflow valve installed incorrectly in the boiler. 4. No draught in chimney. 5. Performance too high (kW) in proportion to boiler. 6. Defective sensor. 7. Air flow wrong. 	<p>Clean the combustion chamber! Clean the boiler, smoke pipe and chimney! Rectify or remove the backflow valve panel in the boiler! Strip the insulation in the smoke pipe, raise the chimney! Contact your dealer! Change the heat sensor on the printed circuit board! Contact chimney-sweep or NBE!</p>
ALARM FAULTY IGNITION	<ol style="list-style-type: none"> 1. Burner grate not fitted correctly. 2. Ash/cinders in the combustion head. 3. Damp pellets. 4. Ignition not fitted correctly. 5. Defective ignition. 6. Excessive chimney draught. 7. Photo sensor is faulty/covered in soot. 8. Blocked ventilator. 	<p>Check the burner grate. Clean the combustion chamber! Change supplier/storage! Fit into quadrangular holder. Change ignition/ignite manually! Install a draught stabilizer in the chimney. Clean/change the sensor. Clean the ventilator and check that it works.</p>
ALARM LOW BOILER TEMPERATURE	Boiler temperature has not exceeded 35 degrees after 2 hours of operation, or has dropped below 35 degrees when running.	<p>Low burner performance. Check pellet feed/ventilator! Check that the temp. sensor is on the boiler.</p>
ALARM PLUG NOT FITTED	<ol style="list-style-type: none"> 1. Plug on the burner is not fitted correctly. 2. Dirt in the plug. 3. Faulty sensor. 	<p>Check the plug on the burner ! Clean any pellet residue from the plug. Change the sensors (photo/temperature).</p>
Control display is black	<ol style="list-style-type: none"> 1. Boiler overheated 2. Control fuses broken. 3. Contrast button not set on controls. 	<p>Reset overheating fuse! Change the fuses. Check for short circuits! Set contrast button.</p>
Burner ejects HFI relay	<ol style="list-style-type: none"> 1. Ignition faulty. 2. Faulty cables. 	<p>Change Ignition/ignite manually! Check cables and plug on the burner. Check condition of burner.</p>
Burner goes out on "LOW STEAM" Weak flame	<ol style="list-style-type: none"> 1. Fuel supply instable. 2. Pellets remain in pipe. 3. Low feed is set too low. 4. Chimney draught estimated wrongly. 5. Amount in auger measured incorrectly. 	<p>Check there is no sawdust at the entrance to the auger. Check the slope of the auger. Check that the auger drops into the combustion chamber. Increase chimney draught and watch LX indicator at low performance. Measure the auger again for 360 seconds.</p>
Burner goes out on "PAUSE" Weak flame	<ol style="list-style-type: none"> 1. Pellets supply instable. 2. Pellets remain in pipe. 3. Chimney draught is set too low. 4. Chimney draught too strong. 	<p>Check there is no sawdust at the entrance to the auger. Check the slope of the auger. Check that the auger drops into the combustion chamber. Watch LX indicator during pause. Increase chimney draught. Install a draught stabilizer in the chimney.</p>
Excessive pellet consumption / boiler will not reach required tem- perature	<ol style="list-style-type: none"> 1. Combustion set incorrectly. 2. Chimney draught too strong. 3. Backflow valve installed incorrectly in the boiler. 4. Bad boiler /low efficiency/ insulation. 5. Combustion chamber working too hard. 6. Damp pellets/poor quality. 	<p>Check that the ash is dark grey! Measure the chimney draught / install a draught stabilizer. Check boiler, install backflow valve. Measure smoke temperature, insulate the boiler! Reduce performance of combustion chamber. Use efficient pellets.</p>
Boiler and burner are clogged up / black.	<ol style="list-style-type: none"> 1. Too many pellets. 2. Lag set incorrectly. 3. Blocked ventilator. 	<p>Increase auger performance in calculation program. Reduce chimney draught. Clean the ventilator!</p>

Manual

NBE Pellets Systems ELECTRICAL WIRING DIAGRAMS

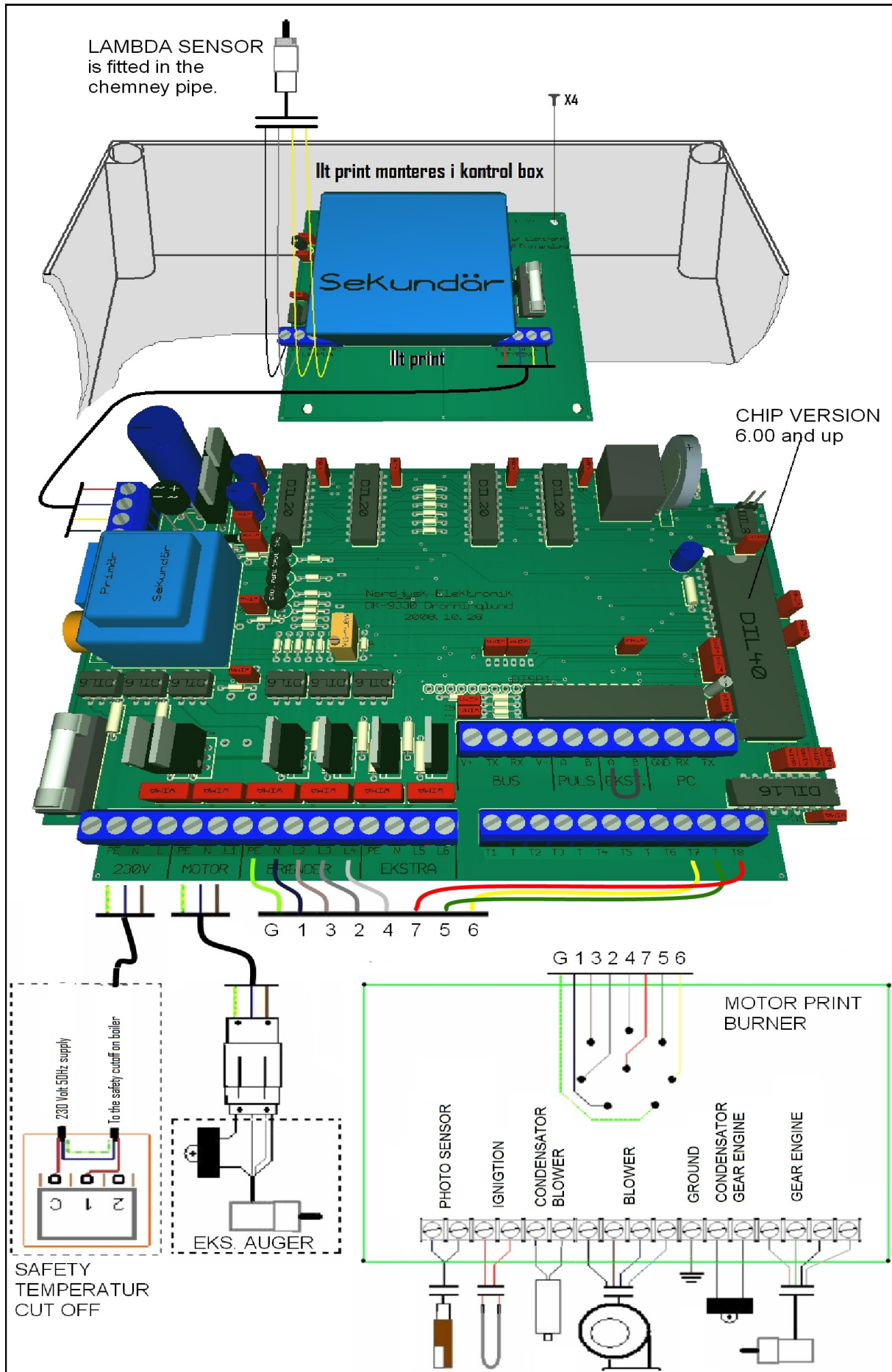

Manual

NBE Pellets Systems ELECTRICAL WIRING DIAGRAMS

	IN	OUT	
POWER	PE-N-L		Power to controlbox
AUGER		PE-N-L1	External auger
BLOWER		PE-N-L2	
INT. AUGER		PE-N-L3	Internal auger
IGNITION		PE-N-L4	
EKSTRA 1		PE-N-L5	Pump, hotwater valve , compressor cleaning
EKSTRA 2		PE-N-L6	Pump, hotwater valve , compressor cleaning
BUS	V+, TX, RX, V-		Intelligent motor print
PULS	A-B		Water flowmeter
EKST	A-B		External power off / on
PC	GND, RX, TX		Computer interface
Boiler Temp.	T1 - T		
Smoke Temp.	T2 - T		
Boiler return Temp.	T3 - T		
Hot water Temp.	T4 - T		
Out side Temp.	T5 - T		
Watt / m2 sensor.	T6 - T		
Burner Temp.	T7 - T		Motor print
Photo Sensor	T8 - T		Motor print

TEKST IN DISPLAY	
WAIT	Updating temperature sensor
IGNITION 1	First ignition.
IGNITION 2	Second ignition.
POWER	Regular mode.
HOT WATER	Hot Water mode
PAUSE	Pause firing.
COLD BOILER	Boiler temperature has been to low and.
STOP	Pellets burner has stopped and waiting for the temperature to drop.
SUMMER STOP	Out temperature is high and the burner has stopped.
SUN STOP	Watt / m2 is to high and the burner has stopped.
HOT BURNER	The burner has been to high and is in an alarm..
PLUG DISCONNECTED	Plug on the burner is disconnected.
FAULT IGNITION	The burner couldn't ignite and got in to an alarm.
OFF	The burner is turned off.
FAULT BOILER TEMP.	The boiler temperature sensor is out of range.
FAULT PHOTO SENSOR	The photo sensor is out of range.
FAULT BURNER TEMP.	The burner temperature sensor is out of range.
FAULT OUTPUT	An relay is broken.
NO LIGHT	Flashing when light sensor can see light, after 5 minutes it is an alarm
FORCE RUNNING AUGER	Force running auger.
CLEANING	The burner is cleaning, with more fan speed.
WOOD FIRING	O2 % has been 2% under the allowed level for more than X minutes
COMPRESSOR CLEANING	The burner is using compressor cleaning

Manual

NBE Pellets Systems
ACCESSORIES

There can be coupled a different types of extra equipment to the burner

Smoke temperature:**Part. No. 180503**

Get an reading on the control box.

O2 regulation:**Part. No. 100701**

The burner adjusting the fan according to the feed of pellets.

Outside temperature sensor:**Part. 300581800-25**

Be able to stop burner according outside temperature.

Hot water temperature sensor and 3 way valve.**Part. 300581800-25 + Part. 3DN20**

Be able to heat only the hot water when needed.

Watt / m2 solar irradiation sensor:**Part. 300581800-50**

Be able to stop burner according to the power of the sun.

Compressor cleaning:**Part. No. 100401**

Build compressor cleaning on you burner, and be able to clean automatic.

Flow counter:**Part. 300581800-12 + Part. 300581800-24**

Get an reading of kwh and litre/hour on your control box.

Interface:**Part. No. 100500**

With interface opens up numerous possibilities for adjustment and adaptation.

The main characteristics are:

- *Show live stats for your pellets burner.
- *Publish statistics to the Internet and keep track of your burner wherever you are.
- *Control your burning at home or from the Internet.
- *Keep an eye on your pellets consumption through manageable consumption graphs.
- *Save money by fine tune your pellets burner to the extreme.
- *Receive an email if there is an emergency.
- *More than 40 options can be set to optimize your burner.
- *Lower the temperature at night.
- *See the operation status from your mobile phone (WAP).
- *And much more.....

Parameter	Værdi
Tilstand	Shukket
Alarm	0
Ydelse	0
Effekt	0.0
Ønsket kedel temp.	49
Kedel temperatur	41.2
Røg temperatur	33
Skakt temperatur	22
Foto sensor	0
Mætning lav	2.2
Mætning høj	24.0
Ønsket ilt %	0.0
Aktuel ilt %	0.0
Træpilleforbrug	3717.92
Køretid snegl	892301
Snegl ydelse / 6 min.	1500
Drift tid eltænding	49182
Skorstens træk	3
Ude temperatur	15.1

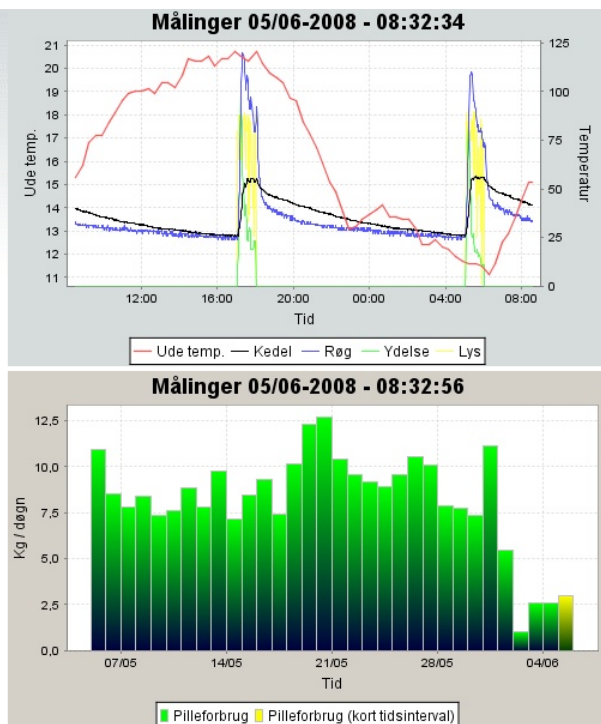

Manual

NBE Pellets Systems WARANTY

All products purchased from NBE are naturally covered by the applicable Danish purchasing law. Products come with a two-year warranty valid from the date of receipt.

However, this does not cover the exhaust gas oxygen sensor, electrical ignition or the combustion grate. These are considered to be replaceable parts.

The warranty only covers production and material faults.

If there is a fault with goods under warranty,

NBE will send a replacement part for repair at no cost to the purchaser.

The purchaser shall install the replacement part himself.

If NBE offers to repair a defective part, the purchaser shall send it to NBE, who will repair it and then return it.

The warranty becomes void if the fault is caused through circumstances caused by the purchaser, by accident, or by improper use of the goods, incorrect cleaning, chimney condition, as well as circumstances unrelated to NBE. In addition to this the warranty becomes void upon improper use of the boiler, for example by using fuel not approved by NBE. The warranty does not cover parts such as the exhaust gas oxygen sensor, electrical ignition and combustion grate. The purchaser is obliged to check the goods immediately upon receipt. If on the basis of this inspection the purchaser would like to make a claim to the effect that the delivery was inadequate or somehow at fault, the customer must immediately file the claim with NBE without delay. Goods can only be returned upon agreement with NBE. To the extent that NBE is liable to the purchaser, the responsibility of NBE is limited to direct damage, i.e. damage to connected equipment, and indirect damage, for loss of earnings, operating losses, connection costs, etc.

responsibility:

NBE accepts no responsibility as a result of the purchaser's legal relations with third parties.

All orders are accepted with the exception of *force majeure*, such as war, civil unrest, natural catastrophes, strikes and lockouts, breakdown in the supply of raw materials, fire, damage to NBE or its supplier network, breakdown in transport facilities, bans on import or export or any other event which prevents or restricts NBE from supplying its goods.

In the case of *force majeure*, NBE may choose to either cease trading in full or in part, or to supply the contractual goods as soon as the obstacle preventing normal delivery has passed. In the event of *force majeure*, NBE is in no way responsible for any damage caused to the supplier as a result of its failure to deliver.

We do not vouch for printing errors, price adjustments, changes in the exchange rate, sold-out goods or changes to specifications in products such as the manual.

It is the purchaser's responsibility to have the equipment registered with the appropriate offices; any disputes between the authorities and the purchaser do not relate to NBE and are not its responsibility.

Upon request the following documents can be issued:

12. Exception to pressure expansion from Work Supervisor.

13. Declaration of conformity.

14. DTI type approval (Danish Technological Institute).

15. Printed circuit board diagrams.

This material is also available at www.nordjysk-bioenergi.dk.

Manual

NBE Pellets Systems MOUNTING THE PELLET HOPPER

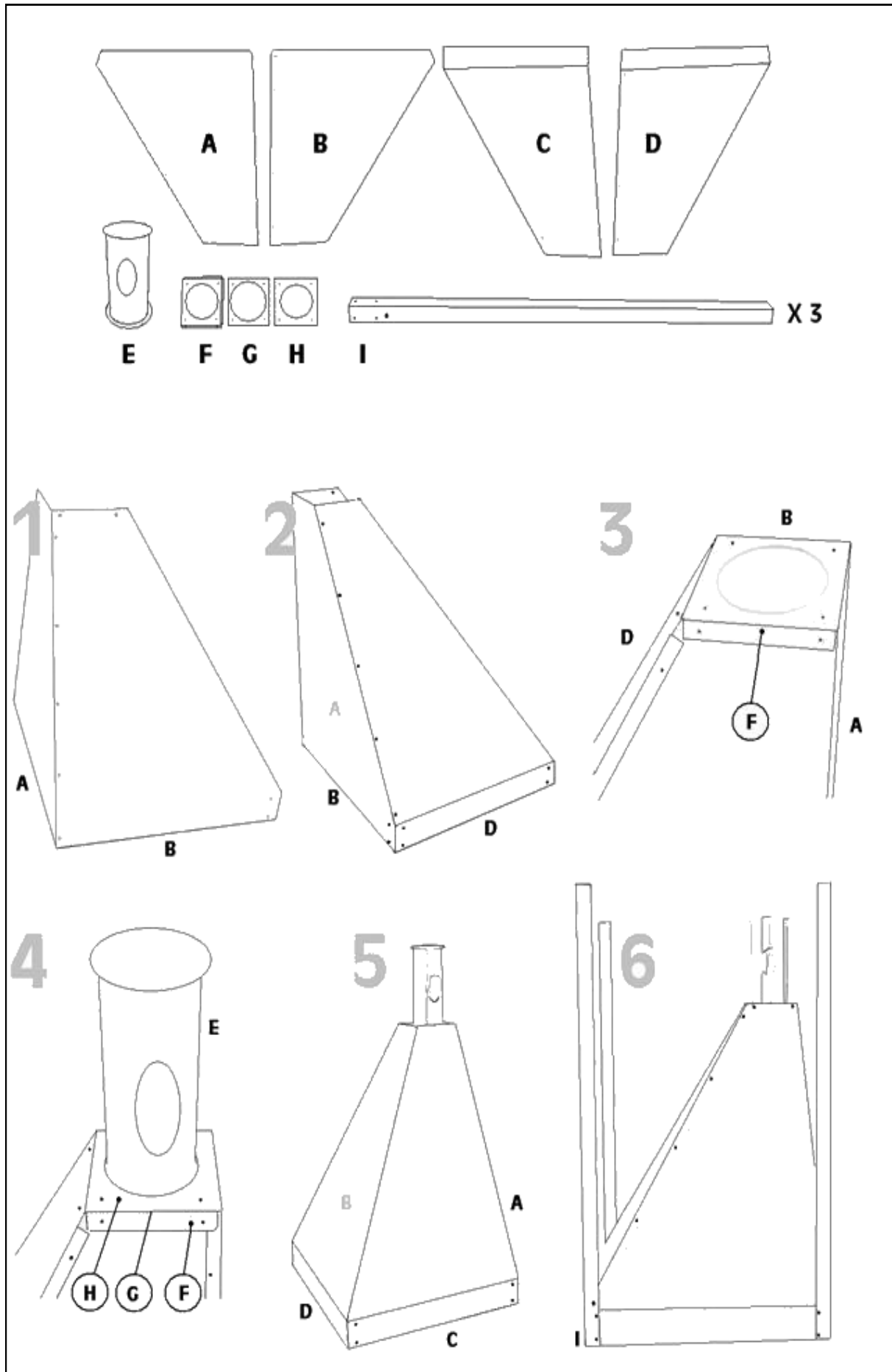

Manual

NBE Pellets Systems

EXCEPTION FOR PRESSURE EXPANSION

NBE
Jannich Hansen
Brinken 10
DK 9830 Oester Vraa

Landskronegade 33
2100 Copenhagen
Telephone 39152000
www.arbejdstilsynet.dk
Your contact JH
Our ref. 20030027413
Our contact.
G.Agersnap
Direct telephone
0045-3915265915

Re: Use of burner to burn wooden pellets type Woody, Scotte, Bio-comfort and Boink in boiler equipment in relation to smaller, closed facilities in compliance with Work Supervisor Regulations for Hot-water Heating Systems. (publ. 42/1980 para 4)

With regard to your query of 1 September 2006 concerning the use of the burner to burn wooden pellets type Woody, Scotte, Bio-comfort and Boink in boiler equipment in relation to smaller, closed facilities with pressure expansion, we can report that the Work Supervisor has perused the submitted materials and can declare that the burner for wooden pellets type Woody, Scotte, Bio-comfort and Boink can be installed in the heat facilities listed in paragraph 4 of the Work Supervisor publication no. 42/1980, Regulations for Hot-water Heating Systems.

It is assumed that the boiler contains the requisite amount of water and that the entire heating facility is designed in exact compliance with the instructions given in publication 42/1980, and also that the electricity supply will only be connected to a boiler with a fitted and connected thermostat with the appropriate overheating safety fuse which must be manually reconnected after activation.

All heating in the boiler must take place by means of the pellet combustion chamber, and only fuels listed in the instructions may be used. Otherwise the equipment must be installed with an open expansion (compare paragraph 2 in publication 42/1980).

This decision is based on the enclosed instructions and diagrams, Test Report no. 300-ELAB-0741, as well as the Power Dropout Test with readings recording the build-up of heat in the boiler if the power supply to the equipment is interrupted.

Best regards,

G.Agersnap

Manual

NBE Pellets Systems

EC DECLARATION OF CONFORMITY

EC DECLARATION OF CONFORMITY

No. : 2205-2008

The undersigned, representing the following manufacturer

manufacturer : NBE

address : Brinken 10, DK9750 Oester Vraa

or representing the manufacturer's authorized representative established within the Community (or the EEA) indicated hereafter

authorized representative :

address :

herewith declares that the product

product identification :

Pellets burner : Woody, Scotte, Boink, Bio Comfort

is in conformity with the provisions of the following EC directive(s)
(including all applicable amendments)

Reference n °	Title
EN 303-5	Europe Norm
73/23/EEC	Low Voltage Directive
89/336/EØF	EMC directive (EMCD)
97/23/EEC	Pressure Equipment Directive
98/37/EF	Machinery directive

and that the standards and/or technical specifications referenced overleaf have been applied.

Last two digits of the year in which the CE marking was affixed: ...03

Jannich Hansen

Oester Vraa

22/05/2008

Jannich Hansen

(signature)

Jannich Hansen, Director

(name and function of the signatory empowered to bind the manufacturer or his authorized representative)